

ACTIONS PROMOTIONNELLES

PRIX PROMOTIONNELS NET HT
OFFRE VALABLE JUSQU'AU 30 JUIN 2018



FRAISES

FRAISES CARBURES INOX HPC	2
FRAISES CARBURES FIGHTMAX	5
FRAISES CARBURES ECONOMY-LINE	5
FRAISES CARBURES	7
FRAISES CARBURES 2 TAILLES	8
FRAISES HSS CO5	9
FRAISES 505 WX6	9
FRAISES RN540 TIPC1370	10

FORETS

FORETS HELICOIDAUX CARBURE MONOBLOC	11
FORETS CYLINDRIQUES COURTS	12

TARAUDS MACHINE

TARAUDS MACHINE HAUTE PERFORMANCE	13
-----------------------------------	----

FRAISES CARBURES ET INOX HPC

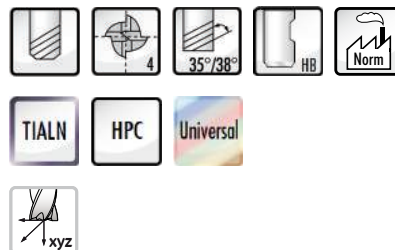
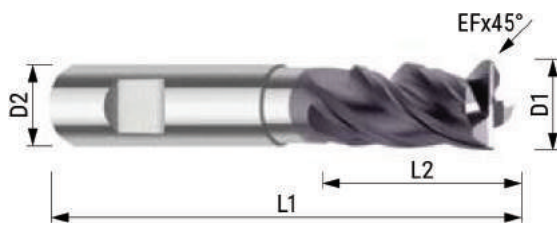

Articles 1.742 ...

D1	D2 H6	L2	L1	EF	Z	Articles	Code	Prix tarif € net HT	Prix promo € net HT
6,00	6,00	13	57	0,2	4	174206010	366255	12,35	8,82
8,00	8,00	19	63	0,2	4	174208010	366256	18,03	12,88
10,00	10,00	22	72	0,2	4	174210010	366257	23,59	16,85
12,00	12,00	26	83	0,2	4	174212010	366258	33,99	24,48
16,00	16,00	32	92	0,2	4	174216010	366259	53,56	38,26
20,00	20,00	38	104	0,2	4	174220010	366260	81,37	58,12

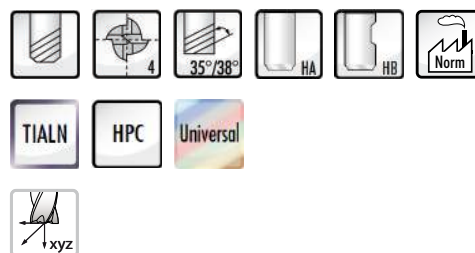
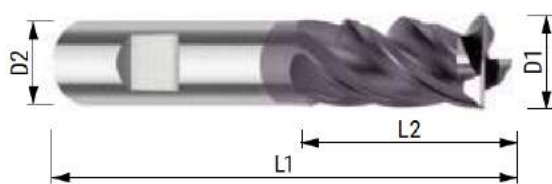

Articles 1.743 ...

D1	D2	L2	L1	D3	L3	EF	Z	Articles	HA	HB	Code		Prix tarif € net HT	Prix promo € net HT
											HA	HB		
3,00	6,00	8	57	2,80	18	0,13	4	1.743.03000	.10	366280	366261	16,48	11,77
4,00	6,00	11	57	3,60	21	0,13	4	1.743.04000	.10	366281	366262	16,48	11,77
5,00	6,00	13	57	4,60	21	0,13	4	1.743.05000	.10	366282	366263	16,48	11,77
6,00	6,00	13	57	5,50	21	0,13	4	1.743.06000	.10	366283	366264	16,48	11,77
8,00	8,00	19	63	7,50	27	0,13	4	1.743.08000	.10	366284	366265	13,18	16,56
10,00	10,00	22	72	9,50	32	0,13	4	1.743.10000	.10	366285	366266	28,84	20,60
12,00	12,00	26	83	11,50	38	0,13	4	1.743.12000	.10	366286	366267	40,17	28,70
16,00	16,00	32	92	15,50	44	0,13	4	1.743.16000	.10	366287	366268	61,70	44,07
20,00	20,00	38	104	19,50	54	0,13	4	1.743.20000	.10	366288	366269	91,67	65,49

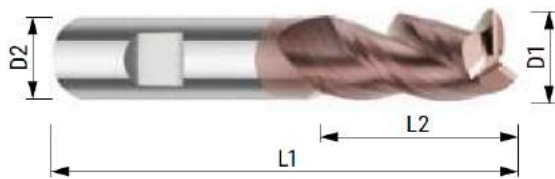

Articles 1.929 ...

D1	D2	L2	L1	EF	Z	Articles	Code	Prix tarif € net HT	Prix promo € net HT
3,00	6,00	8	57	0,10	3	1.929.030.10 ...	366185	12,88	10,73
4,00	6,00	11	57	0,10	3	1.929.040.10 ...	366186	12,36	10,73
5,00	6,00	13	57	0,15	3	1.929.050.10 ...	366187	13,49	11,25
6,00	6,00	13	57	0,20	3	1.929.060.10 ...	366188	14,06	11,72
8,00	8,00	19	63	0,20	3	1.929.080.10 ...	366189	19,06	15,88
10,00	10,00	22	72	0,20	3	1.929.100.10 ...	366190	25,03	20,87
12,00	12,00	26	83	0,30	3	1.929.120.10 ...	366191	34,98	29,15
16,00	16,00	32	92	0,30	3	1.929.160.10 ...	366192	55,04	45,87
20,00	20,00	38	104	0,40	3	1.929.200.10 ...	366193	85,08	70,90

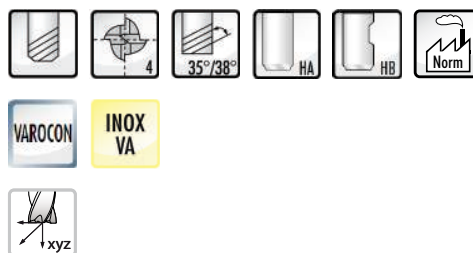
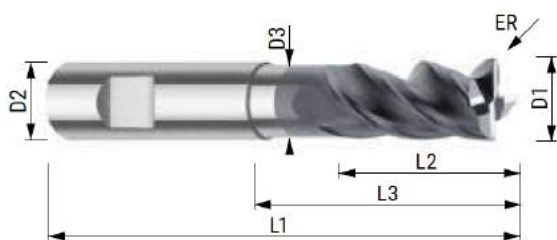

Articles 1.390 ...

D1	D2	L2	L1	D3	L3	EF	Z	Articles	HA	HB	Code		Prix € net HT
											HA	HB	
3,00	6,00	8	57	2,75	18	0,2	4	1.390.03000	.10	366330	366901	18,54
4,00	6,00	11	57	3,50	21	0,2	4	1.390.04000	.10	366331	366902	18,54
5,00	6,00	13	57	4,50	21	0,2	4	1.390.05000	.10	366332	366903	18,50
6,00	6,00	13	57	5,50	21	0,2	4	1.390.06000	.10	366333	366090	18,54
8,00	8,00	19	63	7,50	27	0,2	4	1.390.08000	.10	366334	366091	25,13
10,00	10,00	22	72	9,50	32	0,2	4	1.390.10000	.10	366335	366092	34,51
12,00	12,00	26	83	11,50	38	0,2	4	1.390.12000	.10	366336	366093	47,38
16,00	16,00	32	92	15,50	44	0,2	4	1.390.16000	.10	366337	366094	72,62
20,00	20,00	38	104	19,50	54	0,2	4	1.390.20000	.10	366338	366095	107,64

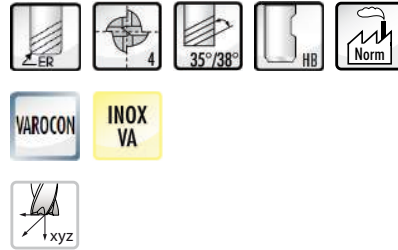
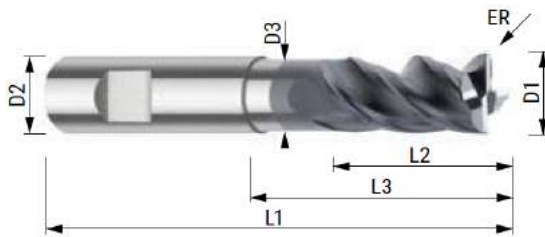

Articles 1.393 ...

D1	D2	L2	L1	D3	L3	EF	Z	Articles	Code	Prix € net HT
8,00	8,00	19	63	7,5	27	0,5	4	1.393.081.10 ...	366905	26,78
8,00	8,00	19	63	7,5	27	1,0	4	1.393.082.10 ...	366906	26,78
8,00	8,00	19	63	7,5	27	1,5	4	1.393.083.10 ...	366907	26,78
8,00	8,00	19	63	7,5	27	2,0	4	1.393.084.10 ...	366908	26,78
8,00	8,00	19	63	7,5	27	2,5	4	1.393.085.10 ...	366909	26,78
10,00	10,00	22	72	9,5	32	0,5	4	1.393.101.10 ...	366911	36,57
10,00	10,00	22	72	9,5	32	1,0	4	1.393.102.10 ...	366912	36,57
10,00	10,00	22	72	9,5	32	1,5	4	1.393.103.10 ...	366913	36,57
10,00	10,00	22	72	9,5	32	2,0	4	1.393.104.10 ...	366914	36,57
10,00	10,00	22	72	9,5	32	2,5	4	1.393.105.10 ...	366915	36,57
10,00	10,00	22	72	9,5	32	3,0	4	1.393.106.10 ...	366916	36,57
10,00	10,00	22	72	9,5	32	4,0	4	1.393.107.10 ...	366917	36,57
12,00	12,00	26	83	11,5	38	0,5	4	1.393.121.10 ...	366919	49,96
12,00	12,00	26	83	11,5	38	1,0	4	1.393.122.10 ...	366920	49,96
12,00	12,00	26	83	11,5	38	1,5	4	1.393.123.10 ...	366921	49,96
12,00	12,00	26	83	11,5	38	2,0	4	1.393.124.10 ...	366922	49,96
12,00	12,00	26	83	11,5	38	2,5	4	1.393.125.10 ...	366923	49,96
12,00	12,00	26	83	11,5	38	3,0	4	1.393.126.10 ...	366924	49,96
12,00	12,00	26	83	11,5	38	4,0	4	1.393.127.10 ...	366925	49,96
16,00	16,00	32	92	15,5	44	0,5	4	1.393.161.10 ...	366927	76,22
16,00	16,00	32	92	15,5	44	1,0	4	1.393.162.10 ...	366928	76,22
16,00	16,00	32	92	15,5	44	1,5	4	1.393.163.10 ...	366929	76,22
16,00	16,00	32	92	15,5	44	2,0	4	1.393.164.10 ...	366930	76,22
16,00	16,00	32	92	15,5	44	2,5	4	1.393.164.10 ...	366931	76,22
16,00	16,00	32	92	15,5	44	3,0	4	1.393.166.10 ...	366932	76,22
16,00	16,00	32	92	15,5	44	4,0	4	1.393.167.10 ...	366933	76,22
20,00	20,00	38	104	19,5	54	0,5	4	1.393.201.10 ...	366935	112,27
20,00	20,00	38	104	19,5	54	1,0	4	1.393.202.10 ...	366936	112,27
20,00	20,00	38	104	19,5	54	1,5	4	1.393.203.10 ...	366937	112,27
20,00	20,00	38	104	19,5	54	2,0	4	1.393.204.10 ...	366938	112,27
20,00	20,00	38	104	19,5	54	2,5	4	1.393.205.10 ...	366939	112,27
20,00	20,00	38	104	19,5	54	3,0	4	1.393.206.10 ...	366940	112,27
20,00	20,00	38	104	19,5	54	4,0	4	1.393.207.10 ...	366941	112,27

FRAISES CARBURES FIGHTMAX

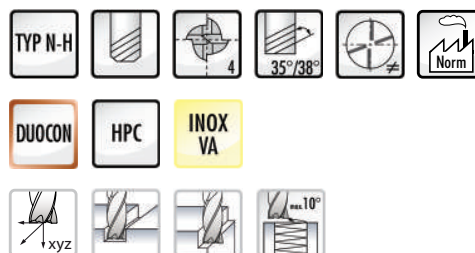
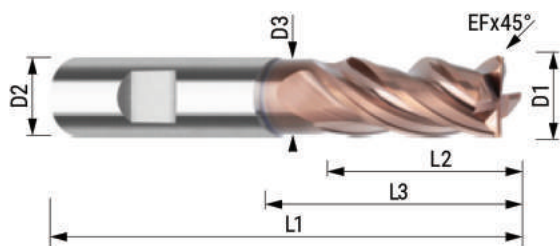

Articles 288 ...

D1	D2	L2	L1	D3	L3	EF	Z	Articles	HA	HB	Code		Prix tarif € net HT	Prix promo € net HT
											HA	HB		
6,00	6,00	13	57	5,50	21	0,13	4	288.06000	.10	364349	363757	37,50	25,86
8,00	8,00	19	63	7,50	27	0,15	4	288.08000	.10	364350	363758	49,90	34,11
10,00	10,00	22	72	9,50	32	0,20	4	288.10000	.10	364351	363759	69,90	48,21
12,00	12,00	26	83	11,50	38	0,52	4	288.12000	.10	364352	363760	91,90	63,38
16,00	16,00	32	92	15,50	44	0,35	4	288.16000	.10	364353	363761	162,50	112,07
20,00	20,00	38	104	19,20	54	0,40	4	288.20000	.10	364354	363762	221,50	152,76

FRAISES CARBURES ECONOMY-LINE

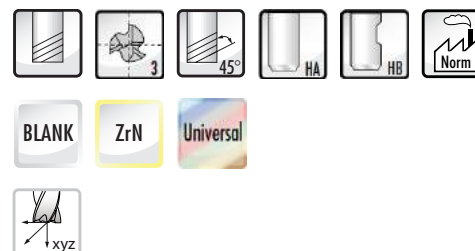
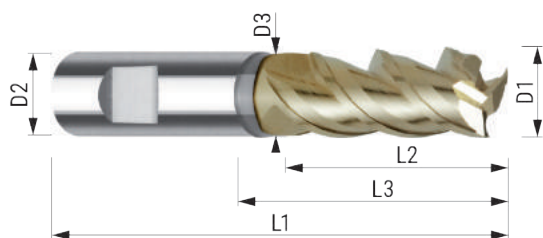

Articles 945 ...

D1	D2	L2	L1	D3	L3	EF	Z	Articles	HA	HB	Code		Prix tarif € net HT	Prix promo € net HT
											HA	HB		
6,00	6,00	13	57	5,50	21	0,13	4	288.06000	.10	364349	363757	37,50	25,86
8,00	8,00	19	63	7,50	27	0,15	4	288.08000	.10	364350	363758	49,90	34,11
10,00	10,00	22	72	9,50	32	0,20	4	288.10000	.10	364351	363759	69,90	48,21
12,00	12,00	26	83	11,50	38	0,52	4	288.12000	.10	364352	363760	91,90	63,38
16,00	16,00	32	92	15,50	44	0,35	4	288.16000	.10	364353	363761	162,50	112,07
20,00	20,00	38	104	19,20	54	0,40	4	288.20000	.10	364354	363762	221,50	152,76

FRAISES CARBURES ECONOMY-LINE

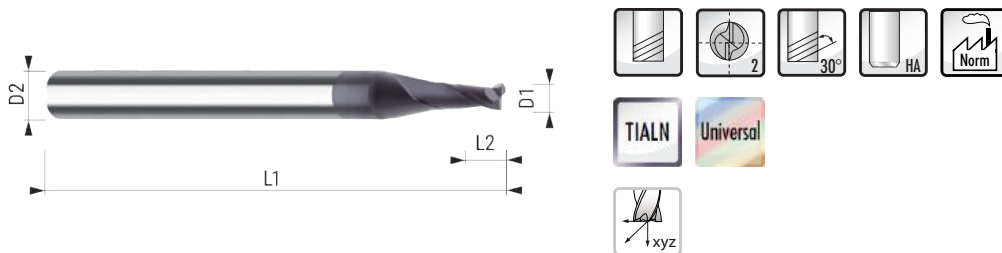

Articles 913.2 ...

D1 H10	L1	L	D2 H6	Z	Articles	Code	Prix € net HT
0,5	1,0	38	3	2	91320500	366225	8,29
0,6	1,2	38	3	2	91320600	366226	8,29
0,7	1,4	38	3	2	91320700	366227	8,29
0,8	1,6	38	3	2	91320800	366228	8,29
0,9	1,8	38	3	2	91320900	366229	8,29
1,0	2,0	38	3	2	91321000	366230	7,69
1,1	2,0	38	3	2	91321100	366231	7,69
1,2	2,0	38	3	2	91321200	366232	7,69
1,4	2,0	38	3	2	91321400	366233	7,69
1,5	2,0	38	3	2	91321500	366234	7,69
1,6	2,0	38	3	2	91321600	366235	7,11
1,7	3,0	38	3	2	91321700	366236	7,11
1,8	3,0	38	3	2	91321800	366237	7,11
1,9	3,0	38	3	2	91321900	366238	7,11
2,0	3,0	38	3	2	91322000	366239	7,11
2,5	3,0	38	3	2	91322500	366240	7,11
3,0	3,0	38	3	2	91323000	366241	7,11

FRAISES CARBURES

DEUX DENTS - SÉRIE COURTE

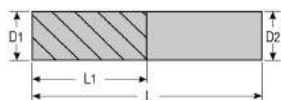

D1	L1	L	D2 H6	Z	Code	Prix € net HT
2	6	40	2	2	366200	9,64
2,5	8	40	2,5	2	366201	9,64
3	8	40	3	2	366202	9,64
3,5	8	50	3,5	2	366203	9,64
4	12	40	4	2	366204	9,64
4,5	12	40	4,5	2	366209	9,64
5	14	50	5	2	366205	9,64
5,5	14	50	5,5	2	366211	10,42
6	16	50	6	2	366206	10,42
6,5	16	60	6,5	2	366207	11,70
8	20	60	8	2	366208	11,70
10	22	70	10	2	366210*	20,20
12	22	70	12	2	366212*	27,34
14	22	83	14	2	366214*	40,79
16	25	75	16	2	366216*	44,73
18	26	92	18	2	366218*	53,36
20	32	100	20	2	366220*	78,58

* Jusqu'à épuisement des stocks

TROIS DENTS - SÉRIE COURTE

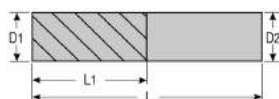

* Jusqu'à épuisement des stocks

D1	L1	L	D2 H6	Z	Code	Prix € net HT
2	6	40	2	3	366300	9,34
2,5	10	40	2,5	3	366301	9,88
3	10	40	3	3	366302	9,64
3,5	8	50	3,5	3	366303	10,04
4	12	0	4	3	366304	9,88
4,5	12	40	4,5	3	366307	9,64
5	14	50	5	3	366305	9,64
5,5	14	50	5,5	3	366309	10,41
6	16	50	6	3	366306	10,41
6,5	16	60	6,5	3	366311	12,44
8	20	60	8	3	366308	12,89
10	22	70	10	3	366310	19,83
12	22	70	12	3	366312	29,41
14	25	75	14	3	366314*	33,37
16	25	75	16	3	366316	56,67
18	32	100	18	3	366318*	51,32
20	32	100	20	3	366320	88,66

FRAISES CARBURES 2 TAILLES

TROIS DENTS - SÉRIE COURTE

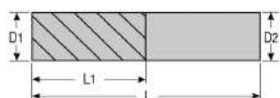

D1	L1	L	D2 H6	Z	CYLINDRIQUE		WELDON	
					Code	Prix	Code	Prix
6	10	57	6	3	366866	10,97	366806	10,97
8	16	63	8	3	366868	15,86	366808	15,86
10	19	72	10	3	366870	21,18	366810	21,18
12	22	83	12	3	366872	30,52	366812	30,52
16	26	92	16	3	366876	50,97	366816	50,97
18	32	104	18	3	-	-	366818*	-
20	32	104	20	3	366880	79,54	366820	79,54

QUATRE DENTS - SÉRIE COURTE

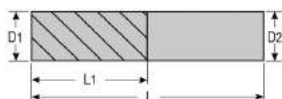

D1	L1	L	D2 H6	Z	Code	Prix € net HT
2	6	40	2	4	366400	10,02
2,5	10	40	2,5	4	366401	10,02
3	10	40	3	4	366402	10,26
3,5	10	50	3,5	4	366403	10,02
4	11	50	4	4	366404	10,02
4,5	12	40	4,5	4	366407	10,90
5	13	50	5	4	366405	10,41
5,5	14	50	5,5	4	366409	14,61
6	13	57	6	4	366406	14,60
6,5	16	60	6,5	4	366411	18,39
8	19	63	8	4	366408	15,58
10	22	72	10	4	366410	23,23
12	26	83	12	4	366412	38,56
14	32	92	14	4	366414	53,01
16	32	92	16	4	366416	55,93
18	38	100	18	4	366418	78,64
20	38	100	20	4	366420	86,25

FRAISES RN540 TIPC1370

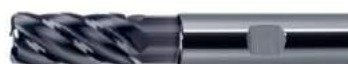
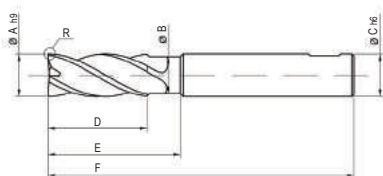

Dimensions						Rayon	Articles	Code	Prix tarif € net HT	Prix promo € net HT
A	B	C	D	E	F	R				
12	11	12	26	35	83	0,8	PLAN N-39930	276088	97,75	71,09
12	11	12	26	35	83	2,5	PLAN N-39929	276089	97,75	71,09
16	15	16	32	48	100	1,0	PLAN N-33114	276093	135,00	98,18
16	15	16	32	48	100	2,5	PLAN N-33115	276094	135,00	98,18
16	15	16	32	48	100	4,0	PLAN N-33116	276095	135,00	98,18
20	18,8	20	38	50	104	2,5	PLAN N-39210	276096	196,87	143,18
20	18,8	20	38	50	104	4,0	PLAN N-39211	276097	196,87	143,18
25	23,5	25	45	60	121	2,5	PLAN N-39212A	276098	309,30	224,95
25	23,5	25	45	60	121	4,0	PLAN N-39213A	276099	309,30	224,95
25	23,5	25	45	60	121	6,0	PLAN N-39928	276100	309,30	224,95

FRAISES HSS CO5

TROIS DENTS - FRAISE 90%



D1	ANGLE	L	D2 H8	Z	HSSE		TIALN	
					CODE	PRIX € NET HT	CODE	PRIX € NET HT
3,00	6,00	8	57	2,75	011470	13,89	011480	20,17
4,00	6,00	11	57	3,50	011471	15,16	011481	21,46
5,00	6,00	13	57	4,50	011472	18,95	011482	25,23
6,00	6,00	13	57	5,50	011473	21,48	011483	27,77
8,00	8,00	19	63	7,50	011474	24,01	011484	30,29
10,00	10,00	22	72	9,50	011475	31,58	011485	37,86
12,00	12,00	26	83	11,50	011476	46,75	011486	53,03
16,00	16,00	32	92	15,50	011477	66,96	011487	73,26

FRAISES 505 WX6



FRAISES 2 TAILLES FINITION - SÉRIE MOYENNE

- NORME USINE
- COUPE AU CENTRE
- HÉLICE 40°



D Js14	Lt	LT	d h8	Z	Code	Prix € net HT
3	8	52	6	4	014387	9,16
4	11	55	6	4	014388	9,16
5	13	57	6	4	014389	9,16
6	16	60	6	4	014390	9,16
7	22	72	10	4	014391	16,02
8	25	75	10	4	014392	16,02
9	25	75	10	4	014393	16,02
10	28	78	10	4	014394	16,02
11	28	85	12	4	014395	22,10
12	32	89	12	4	014396	22,10
13	32	89	12	4	014397	26,67
14	32	92	16	4	014398	29,74
15	36	96	16	4	014399	29,74
16	36	96	16	4	014400	29,74
17	40	200	16	4	014401	34,31
18	40	200	16	4	014402	34,31
19	45	105	16	4	014403	39,66
20	45	111	20	4	014404	39,66
22	46	111	20	5	014405	51,09
25	50	126	25	5	014409	63,28
30	63	139	25	6	014414	79,29
32	63	143	32	6	014415	93,02

FORETS HÉLICOÏDAUX CARBURE MONOBLOC

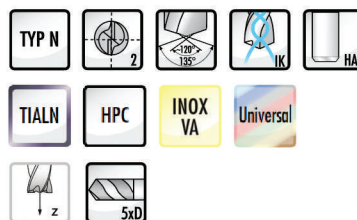
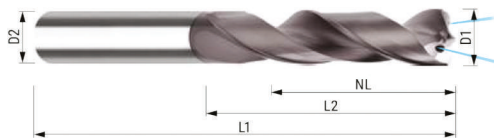

Articles 845 ...

D1 mm	D2 mm	L2 mm	L1 mm	NL mm	Code	Prix promo € net HT	D1 mm	D2 mm	L2 mm	L1 mm	NL mm	Code	Prix promo € net HT	D1 mm	D2 mm	L2 mm	L1 mm	NL mm	Code	Prix promo € net HT	
3,00	6	28	66	23	272150	21,76	6,80	8	53	91	43	272189	25,84	10,70	12	71	118	56	272228	40,80	
3,10	6	28	66	23	272151	21,76	6,90	8	53	91	43	272190	25,84	10,80	12	71	118	56	272229	40,80	
3,20	6	28	66	23	272152	21,76	7,00	8	53	91	43	272191	25,84	10,90	12	71	118	56	272230	40,80	
3,30	6	28	66	23	272153	21,76	7,10	8	53	91	43	272192	25,84	11,00	12	71	118	56	272231	40,80	
3,40	6	28	66	23	272154	21,76	7,20	8	53	91	43	272193	25,84	11,10	12	71	118	56	272232	40,80	
3,50	6	28	66	23	272155	21,76	7,30	8	53	91	43	272194	25,84	11,20	12	71	118	56	272233	40,80	
3,60	6	28	66	23	272156	21,76	7,40	8	53	91	43	272195	25,84	11,30	12	71	118	56	272234	40,80	
3,70	6	28	66	23	272157	21,76	7,50	8	53	91	43	272196	25,84	11,40	12	71	118	56	272235	40,80	
3,80	6	36	74	29	272158	21,76	7,60	8	53	91	43	272197	25,84	11,50	12	71	118	56	272236	40,80	
3,90	6	36	74	29	272159	21,76	7,70	8	53	91	43	272198	25,84	11,60	12	71	118	56	272237	40,80	
4,00	6	36	74	29	272160	21,76	7,80	8	53	91	43	272199	25,84	11,70	12	71	118	56	272238	40,80	
4,10	6	36	74	29	272161	21,76	7,90	8	53	91	43	272200	25,84	11,80	12	71	118	56	272239	40,80	
4,20	6	36	74	29	272162	21,76	8,00	8	53	91	43	272201	25,84	11,90	12	71	118	56	272240	40,80	
4,30	6	36	74	29	272163	21,76	8,10	10	61	103	49	272202	31,28	12,00	12	71	118	56	272241	40,80	
4,40	6	36	74	29	272164	21,76	8,20	10	61	103	49	272203	31,28	12,20	14	77	124	60	272242	59,84	
4,50	6	36	74	29	272165	21,76	8,30	10	61	103	49	272204	31,28	12,30	14	77	124	60	272243	59,84	
4,60	6	36	74	29	272166	21,76	8,40	10	61	103	49	272205	31,28	12,50	14	77	124	60	272244	59,84	
4,65	6	36	74	29	272167	21,76	8,50	10	61	103	49	272206	31,28	12,80	14	77	124	60	272245	59,84	
4,70	6	36	74	29	272168	21,76	8,60	10	61	103	49	272207	31,28	13,00	14	77	124	60	272246	59,84	
4,80	6	44	82	35	272169	21,76	8,70	10	61	103	49	272208	31,28	13,50	14	77	124	60	272247	59,84	
4,90	6	44	82	35	272170	21,76	8,80	10	61	103	49	272209	31,28	13,80	14	77	124	60	272248	59,84	
5,00	6	44	82	35	272171	21,76	8,90	10	61	103	49	272210	31,28	14,00	14	77	124	60	272249	59,84	
5,10	6	44	82	35	272172	21,76	9,00	10	61	103	49	272211	31,28	14,50	16	83	133	63	272250	73,44	
5,20	6	44	82	35	272173	21,76	9,10	10	61	103	49	272212	31,28	14,80	16	83	133	63	272251	73,44	
5,30	6	44	82	35	272174	21,76	9,20	10	61	103	49	272213	31,28	15,00	16	83	133	63	272252	73,44	
5,40	6	44	82	35	272175	21,76	9,30	10	61	103	49	272214	31,28	15,50	16	83	133	63	272253	73,44	
5,50	6	44	82	35	272176	21,76	9,40	10	61	103	49	272215	31,28	15,80	16	83	133	63	272254	73,44	
5,60	6	44	82	35	272177	21,76	9,50	10	61	103	49	272216	31,28	16,00	16	83	133	63	272255	73,44	
5,70	6	28	66	35	272178	21,76	9,60	10	61	103	49	272217	31,28	16,50	18	93	143	71	272256	100,64	
5,80	6	28	66	35	272179	21,76	9,70	10	61	103	49	272218	31,28	16,80	18	93	143	71	272257	100,64	
5,90	6	28	66	35	272180	21,76	9,80	10	61	103	49	272219	31,28	17,00	18	93	143	71	272258	100,64	
6,00	6	28	66	35	272181	21,76	9,90	10	61	103	49	272220	31,28	17,50	18	93	143	71	272259	100,64	
6,10	8	53	91	43	272182	21,76	10,00	10	61	103	49	272221	31,28	17,80	18	93	143	71	272260	100,64	
6,20	8	53	91	43	272183	25,84	10,10	12	71	118	56	272222	40,80	18,00	18	93	143	71	272261	100,64	
6,30	8	53	91	43	272184	25,84	10,20	12	71	118	56	272223	40,80	18,50	18	93	143	71	272262	127,84	
6,40	8	53	91	43	272185	25,84	10,30	12	71	118	56	272224	40,80	19,00	18	93	143	71	272263	127,84	
6,50	8	53	91	43	272186	25,84	10,40	12	71	118	56	272225	40,80	19,50	18	93	143	71	272264	127,84	
6,60	8	53	91	43	272187	25,84	10,50	12	71	118	56	272226	40,80	20,00	18	93	143	71	272265	127,84	
6,70	8	53	91	43	272188	25,84	10,60	12	71	118	56	272227	40,80								

FORETS CYLINDRIQUES COURTS

HSSCO5 TYPE N - SÉRIE COURTE

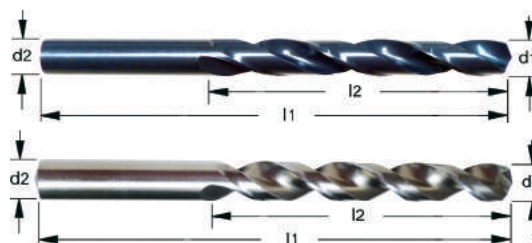
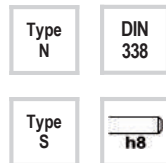

D1 mm	L1 mm	L2 mm	Code	Prix pièce € net HT	PRIX LOT PAR 10	D1 mm	D2 mm	L2 mm	Code	Prix pièce € net HT	PRIX LOT PAR 10	D1 mm	D2 mm	L2 mm	Code	Prix pièce € net HT	PRIX LOT PAR 10
1,00	34	12	022700S	0,61	6,10	4,90	86	52	022778S	1,38	13,80	8,80	125	81	022858S	4,33	43,30
1,10	36	14	022702*	0,69	6,90	5,00	86	52	022780S	1,38	13,80	8,90	125	81	022860S	4,49	44,90
1,20	38	16	022704*	0,69	6,90	5,10	86	52	022782S	1,38	13,80	9,00	125	81	022862S	4,49	44,90
1,25	38	16	022914*	0,80	8,00	5,20	86	52	022784S	1,41	14,10	9,10	125	81	022864S	4,99	49,90
1,30	38	16	022706*	0,69	6,90	5,25	86	52	022922	1,95	19,50	9,20	125	81	022866S	5,02	50,20
1,40	40	18	022708*	0,69	6,90	5,30	86	52	022786S	1,41	14,10	9,25	125	81	022929	4,89	48,90
1,50	40	18	022710S	0,61	6,10	5,40	93	57	022788S	1,49	14,90	9,30	125	81	022868S	5,04	50,40
1,60	43	20	022712S	0,66	6,60	5,50	93	57	022790S	1,49	14,90	9,40	125	81	022870S	5,07	50,70
1,70	43	20	022714S	0,66	6,60	5,60	93	57	022792S	1,49	14,90	9,50	125	81	022872S	5,07	50,70
1,75	46	22	022915	0,82	8,20	5,70	93	57	022794S	1,49	14,90	9,60	125	81	022874S	5,10	51,00
1,80	46	22	022716S	0,66	6,60	5,75	93	57	022923	2,08	20,80	9,70	133	87	022876S	5,15	51,50
1,90	46	22	022718S	0,72	7,20	5,80	93	57	022796S	1,54	15,40	9,75	133	87	022930	4,91	49,10
2,00	49	24	022720S	0,74	7,40	5,90	93	57	022798S	1,54	15,40	9,80	133	87	022878S	5,29	52,90
2,10	49	24	022722S	0,74	7,40	6,00	93	57	022800S	1,52	15,20	9,90	133	87	022880S	5,43	54,30
2,20	53	27	022724S	0,74	7,40	6,10	101	63	022802S	1,62	16,20	10,00	133	87	022882S	5,48	54,80
2,25	53	27	022916	0,84	8,40	6,20	101	63	022804S	1,65	16,50	10,10	133	87	022883S	5,51	55,10
2,30	53	27	022726S	0,77	7,70	6,25	101	63	022924	2,39	23,90	10,20	133	87	022884S	5,70	57,00
2,40	57	30	022728S	0,77	7,70	6,30	101	63	022806S	1,76	17,60	10,25	133	87	022885	5,80	58,00
2,50	57	30	022730S	0,77	7,70	6,40	101	63	022808S	1,76	17,60	10,30	133	87	022886S	5,70	57,00
2,60	57	30	022732S	0,80	8,00	6,50	101	63	022810S	1,76	17,60	10,40	133	87	022887S	5,73	57,30
2,70	61	33	022734S	0,80	8,00	6,60	101	63	022812S	1,82	18,20	10,50	133	87	022888S	5,76	57,60
2,75	61	33	022917	0,99	9,90	6,70	101	63	022814S	1,85	18,50	10,60	133	87	022889	5,82	58,20
2,80	61	33	022736S	0,80	8,00	6,75	109	69	022816	2,65	26,50	10,70	142	94	022890S	5,76	57,60
2,90	61	33	022738S	0,80	8,00	6,80	109	69	022818S	1,85	18,50	10,80	142	94	022891S	5,84	58,40
3,00	61	33	022740S	0,80	8,00	6,90	109	69	022820S	1,96	19,60	10,90	142	94	022892	5,82	58,20
3,10	65	36	022742	0,88	8,80	7,00	109	69	022822S	1,96	19,60	11,00	142	94	022893s	5,95	59,50
3,20	65	36	022744S	0,85	8,50	7,10	109	69	022824S	2,09	20,90	11,10	142	94	022894s	6,31	63,10
3,25	65	36	022918	0,95	9,50	7,20	109	69	022826S	2,09	20,90	11,20	142	94	022895s	6,89	68,90
3,30	65	36	022746S	0,95	9,50	7,25	109	69	022925	3,15	31,50	11,30	142	94	022896S	7,39	73,90
3,40	70	39	022748S	1,10	11,00	7,30	109	69	022828S	2,15	21,50	11,40	142	94	022897S	7,44	74,40
3,50	70	39	022750S	1,16	11,60	7,40	109	69	022830S	2,15	21,50	11,50	142	94	022898S	7,44	74,40
3,60	70	39	022752S	1,19	11,90	7,50	117	75	022832S	2,29	22,90	11,60	142	94	022899	6,91	69,10
3,70	70	39	022754S	1,21	12,10	7,60	117	75	022834S	2,34	23,40	11,70	142	94	022900S	7,44	74,40
3,75	70	39	022919	1,32	13,20	7,70	117	75	022836S	2,40	24,00	11,80	142	94	022901S	7,44	74,40
3,80	75	43	022756S	1,21	12,10	7,75	117	75	022926	3,44	34,40	11,90	151	101	022902	6,91	69,10
3,90	75	43	022758S	1,24	12,40	7,80	117	75	022838S	2,43	24,30	12,00	151	101	022903S	7,88	78,80
4,00	75	43	022760S	1,19	11,90	7,90	117	75	022840S	2,48	24,80	12,10	151	101	022904S	7,99	79,90
4,10	75	43	022762S	1,24	12,40	8,00	117	75	022842S	2,76	27,60	12,20	151	101	022905S	7,99	79,90
4,20	75	43	022764S	1,24	12,40	8,10	117	75	022844S	3,45	34,50	12,30	151	101	022906S	8,02	80,20
4,25	75	43	022920	1,34	13,40	8,20	117	75	022846S	3,61	36,10	12,40	151	101	022907S	8,08	80,80
4,30	80	47	022766S	1,27	12,70	8,25	117	75	022927	3,82	38,20	12,50	151	101	022908S	8,10	81,00
4,40	80	47	022768S	1,27	12,70	8,30	117	75	022848S	3,67	36,70	12,60	151	101	022909S	8,16	81,60
4,50	80	47	022770S	1,30	13,00	8,40	117	75	0228450€	3,86	38,60	12,70	151	101	022910S	8,27	82,70
4,60	80	47	022772S	1,30	13,00	8,50	117	75	022852S	3,67	36,70	12,80	151	101	022911S	8,82	88,20
4,70	80	47	022774S	1,30	13,00	8,60	125	81	022854S	4,49	44,90	12,90	151	101	022912S	9,65	96,50
4,75	80	47	022921	1,49	14,90	8,70	125	81	022856S	4,49	44,90	13,00	151	101	022913S	9,65	96,50
4,80	86	52	022776S	1,30	13,00	8,75	125	81	022928	3,95	39,50	14,00	160	108	022931	9,70	97,00

* Jusqu'à épuisement des stocks

TARAUDS MACHINE HAUTE PERFORMANCE



HSSE

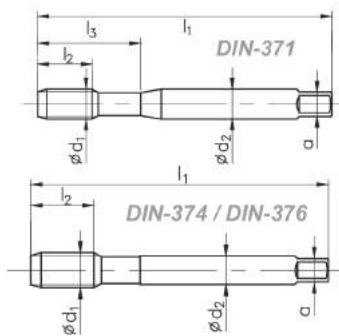

TYPE DE MATÉRIEL
REVÊTEMENT
CHANFREIN

M D1	P	L1	L2	L2 R40	L3	D2	a		INDEX
---------	---	----	----	-----------	----	----	---	--	-------

M3	0,50	56	10	5	18	3,5	2,7	2,50	0030
M4	0,70	63	12	7	21	4,5	3,4	3,30	0040
M5	0,80	70	14	8	25	6,00	4,90	4,20	0050
M6	1,00	80	18	10	35	6,00	4,90	5,00	0060
M8	1,23	90	20	13	35	8,00	6,20	6,80	0080
M10	1,50	100	20	15	39	10,00	8,00	8,50	0100

M8x1	1,00	90	20	10	-	6,00	4,90	7,00	0083
M10x1	1,00	90	20	13	-	7,00	5,50	9,00	0103
M10x1,25	1,20	100	20	15	-	7,00	5,50	8,80	0104

M12	1,75	110	24	18	-	9,00	7,00	10,20	0120
M14	2,00	110	25	20	-	11,00	9,00	12,00	0140
M16	2,00	110	32	20	-	12,00	9,00	14,00	0160
M18	2,50	125	32	25	-	14,00	11,00	15,50	0180
M20	2,50	140	32	25	-	16,00	12,00	17,50	0200
M22	2,50	140	32	25	-	18,00	14,50	19,50	0220
M24	3,00	160	38	30	-	18,00	4,50	21,00	0240
M27	3,00	160	38	30	-	20,00	16,00	24,00	0270
M30	3,50	180	40	35	-	22,00	18,00	26,00	0300
M33	3,50	180	45	35	-	25,00	22,00	29,50	0330
M36	4,00	200	50	40	-	28,00	22,00	32,00	0360

M12x1,5	1,50	100	20	5	-	9,00	7,00	10,20	0125
M14x1,5	1,50	100	20	7	-	11,00	9,00	12,00	0145
M16x1,5	1,50	100	20	8	-	12,00	9,00	14,00	0162

800X

C-R40-TN



B-TN



HSSE
TN
C / 2-3P

HSSE
TN
B / 4-5P

CODE	C2-513X01 PRIX	CODE	C2-113X01 PRIX
------	-------------------	------	-------------------

DIN-371

045751	12,71	9,24	045362	11,72	8,52
045753	12,90	9,39	045364	11,90	8,65
045756	13,92	10,12	045367	12,87	9,36
045758	14,37	10,45	045369	13,32	9,69
045761	17,16	12,48	045372	15,93	11,59
045765	22,47	16,34	045376	20,91	15,21

C2-513X01

C2-113X01

DIN-371

045492	21,29	15,48	045486	19,65	14,29
045493	26,00	18,91	045487	24,14	17,55
045494	29,51	21,46	045488	27,35	19,89

D2-513X01

C2-113X01

DIN-376

045778	31,38	22,82	045389	31,38	22,82
045782	41,55	30,22	045393	41,55	30,22
045787	44,97	32,71	045402	44,97	32,71
045790	61,16	44,48	045399	61,16	44,48
045794	66,71	48,51	045406	66,71	48,51
045798	90,54	65,85	045410	90,54	65,85
045802	91,43	66,46	045414	91,43	66,46
045808	117,26	85,28	045420	117,26	85,28
045813	137,64	100,10	045425	137,64	100,10
045818	186,57	137,14	045430	186,57	137,14
045823	266,78	194,02	045434	266,78	194,02

D2-513X01

C2-113X01

DIN-374

045495	36,32	26,41	045489	33,63	24,46
045496	48,33	35,15	045490	44,63	32,45
045497	50,46	36,70	045491	46,65	33,93

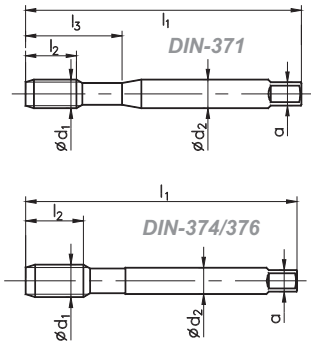

**TOLÉRANCE
REVÊTEMENT
ENTRÉE
GOUJURE**

**ISO2 (H6)
HL
B = 4 - 5 FILETS
DROITE**

**ISO2 (H6)
HL
C = 2 - 3 FILETS
HÉLICOÏDALE**

M	P	L1	L2	L3	D2	a	
D1							
2	0,4	45	8	12	2,8	2,1	1,6
2,5	0,45	50	5	14	2,8	2,1	2,05
3	0,50	56	5	18	3,5	2,1	2,50
4	0,70	63	7	21	4,5	3,4	3,30
5	0,80	70	8	25	6	4,9	4,20
6	1,00	80	10	30	6	4,9	5,00
8	1,25	90	13	35	8	6,2	6,80
10	1,50	100	15	39	10	8	8,50
12	1,75	110	18	-	9	7	10,20
14	2,00	110	20	-	11	9	12,00
16	2,00	110	20	-	12	9	14,00

C4-118M01	
CODE	PRIX
DIN-371	
045711	18,18 15,67
045712	18,18 15,67
045713	14,07 12,12
045714	14,02 12,78
045715	16,09 13,88
045716	16,68 14,38
045717	20,03 17,28
045718	26,35 22,71

C4-528M01	
CODE	PRIX
DIN-371	
045719	20,21 17,41
045720	20,21 17,41
045721	15,63 13,48
045722	16,47 14,19
045723	17,89 15,41
045724	18,52 15,97
045725	22,26 19,19
045726	29,27 25,24

D4-118M31	
CODE	PRIX
DIN-376	
045727	38,82 33,47
045728	50,89 43,86
045729	54,71 47,17

D4-528M01	
CODE	PRIX
DIN-376	
045730	34,13 37,19
045731	56,53 48,72
045732	60,79 52,40



TARAUDS H2ECO

- DIN 371 JUSQU'AU M10
- DIN 37 AU-DELÀ

**TOLÉRANCE
ENTRÉE
GOUJURE**

**6H
C = 2 - 3 FILETS
HÉLICOÏDALE**

			CODE	Prix tarif € net HT	Prix promo € net HT
M3	x	0,5	045104	6,63	4,42
M4	x	0,7	045109	6,63	4,42
M5	x	0,8	045112	6,78	4,52
M6	x	1,0	045115	6,78	4,52
M8	x	1,3	045119	10,18	6,78
M10	x	1,5	045121	11,35	7,57
M12	x	1,8	045123	15,18	10,12
M14	x	2,0	045125	23,98	15,98
M16	x	2,0	045127	26,13	17,42
M18	x	2,5	045129	27,31	20,38
M20	x	2,5	045131	32,82	24,30

PRIX PROMOTIONNELS NET HT - OFFRE VALABLE DANS LA LIMITE DES STOCKS DISPONIBLES - VALIDITE 30-06-2018

TECHMO

SIEGE SOCIAL
30 rue de Montaran
45400 FLEURY LES AUBRAIS
commercial.techmo@techmo.fr
Tél. : 02 38 61 48 10
Fax : 02 38 84 39 63

TECHMO

18 chemin de la Violette
31240 L'UNION
magasin.toulouse@techmo.fr
Tél. : 05 61 61 34 35
Fax : 05 61 61 34 44

TECHMO

9 rue Laplace
33700 MERIGNAC
magasin.merignac@techmo.fr
Tél. : 05 61 61 34 35
Fax : 05 61 61 34 44

TECHMO

95 rue Normandie Niemen
64121 SERRES CASTET
magasin.pau@techmo.fr
Tél. : 05 59 90 34 10
Fax : 05 59 90 08 59

TECHMO

Parc du Chêne
12 rue du 35e Régiment d'Aviation
69500 BRON
magasin.vaulx-en-velin@techmo.fr
Tél. : 02 38 61 48 10
Fax : 05 38 84 39 63

SATECH

28, rue Alain Gerbault
ZAC du panorama
72100 LE MANS
magasin@satech.fr
Tél. : 02 43 40 05 05
Fax : 02 43 40 00 99